

Taal: Engels



# Handleiding

CAV

CA FOX 16

CA FOX 22

**MSH equipment**

Appelmarkt 7

1681 PE Zwaagdijk-Oost

Tel: 0228-561100

Fax: 0228-561112

Mail: [info@msh-equipment.nl](mailto:info@msh-equipment.nl)

Website: [www.msh-equipment.nl](http://www.msh-equipment.nl)



## CONTENTS

|  |           |                                  |           |
|--|-----------|----------------------------------|-----------|
| <b>1 GENERAL INFORMATION</b>           | <b>3</b>  | <b>5.6 DECOMMISSIONING</b>       | <b>15</b> |
| 1.1 MANUFACTURER                       | 3         |                                  |           |
| 1.2 POINTS OF SALE AND SERVICE CENTRES | 3         | <b>6 MAINTENANCE</b>             | <b>15</b> |
| 1.3 CERTIFICATES                       | 3         | 6.1 MACHINE CUT-OFF              | 15        |
| 1.4 WARRANTY                           | 3         | 6.2 SPECIAL PRECAUTIONS          | 15        |
| 1.5 CUSTOMER'S OBLIGATIONS             | 3         | 6.3 PARTS SUBJECT TO MAINTENANCE | 16-17     |
| 1.6 MANUAL LAYOUT                      | 4         | 6.4 CLEANING                     | 18        |
| 1.6.1 PURPOSE AND CONTENTS             | 4         | 6.5 ROUTINE MAINTENANCE          | 18        |
| 1.6.2 MANUAL ADDRESSEES                | 4         | 6.6 EXTRAORDINARY MAINTENANCE    | 18        |
| 1.6.3 MANUAL STORAGE                   | 4         |                                  |           |
| 1.6.4 SYMBOLS                          | 4         | <b>7 DIAGNOSTICS</b>             | <b>19</b> |
|  |           | 7.1 TROUBLESHOOTING              | 19        |
| <b>2 MACHINE DESCRIPTION</b>           | <b>5</b>  | 7.2 AFTER-SALES SERVICE          | 20        |
| 2.1 PRINCIPLE OF OPERATION             | 5         |                                  |           |
| 2.2 MAIN COMPONENTS                    | 5         | <b>8 SPARE PARTS</b>             | <b>20</b> |
| 2.3 MACHINE STRUCTURE                  | 5         | 8.1 SPARE PARTS LIST             | 20        |
| 2.4 DIMENSIONS                         | 5         | 8.2 ORDERING SPARE PARTS         | 21        |
| 2.5 AMBIENT CONDITIONS                 | 5         |                                  |           |
| 2.6 LIGHTING                           | 5         | <b>9 SCRAPPING</b>               | <b>21</b> |
| 2.7 VIBRATIONS                         | 5         | 9.1 DISPOSING OF WASTE           | 21        |
| 2.8 NOISE EMISSIONS                    | 5         | 9.2 MACHINE SCRAPPING            | 21        |
| 2.9 SPECIFICATIONS                     | 6         |                                  |           |
| 2.10 OUTFIT                            | 6         | <b>10 ANNEXES</b>                | <b>21</b> |
| 2.10.1 STANDARD                        | 6         | 10.1 DECLARATIONS                | 26        |
| 2.10.2 OPTION EQUIPMENT ON REQUEST     | 6         | 10.2 DIAGRAMS                    | 22-25     |
| 2.11 ELECTROMAGNETIC ENVIRONMENT       | 6         | 10.3 WARRANTY FORM               | 27        |
|  |           | 10.4 MAINTENANCE LOG BOOK        | 28-29     |
| <b>3 SAFETY RULES</b>                  | <b>7</b>  |                                  |           |
| 3.1 GENERAL WARNINGS                   | 7         |                                  |           |
| 3.2 INTENDED USE                       | 7         |                                  |           |
| 3.3 UNSUITABLE USE                     | 7         |                                  |           |
| 3.4 DANGEROUS AREAS                    | 7         |                                  |           |
| 3.5 SAFETY DEVICES                     | 7         |                                  |           |
| 3.6 STOP CONTROLS                      | 8         |                                  |           |
| 3.7 SAFE WORKING PROCEDURES            | 8         |                                  |           |
| 3.8 RESIDUAL RISKS                     | 8         |                                  |           |
| 3.9 NAMEPLATES                         | 8         |                                  |           |
| <b>4 INSTALLATION</b>                  | <b>9</b>  |                                  |           |
| 4.1 TRANSPORT AND HANDLING             | 9         |                                  |           |
| 4.2 STORAGE                            | 9         |                                  |           |
| 4.3 ARRANGEMENTS BEFORE INSTALLATION   | 9         |                                  |           |
| 4.4 ASSEMBLY                           | 10        |                                  |           |
| 4.5 SET-UP                             | 10        |                                  |           |
| 4.6 CONNECTIONS                        | 11        |                                  |           |
| 4.6.1 PNEUMATIC CONNECTIONS            | 11        |                                  |           |
| 4.6.2 ELECTRIC CONNECTIONS             | 12        |                                  |           |
| 4.6.3 SUCTION                          | 13        |                                  |           |
| 4.6.3a OUTLET                          | 13        |                                  |           |
| 4.7 PRELIMINARY INSPECTION             | 13        |                                  |           |
| 4.8 ADJUSTMENTS AND CHECKS             | 13        |                                  |           |
| <b>5 OPERATION</b>                     | <b>14</b> |                                  |           |
| 5.1 PERSONNEL                          | 14        |                                  |           |
| 5.2 CONTROL PANEL                      | 14        |                                  |           |
| 5.3 COMMISSIONING AND USE              | 14        |                                  |           |
| 5.4 OPERATING MODES                    | 15        |                                  |           |
| 5.5 JOB END                            | 15        |                                  |           |



## 1 GENERAL INFORMATION

### 1.1 MANUFACTURER

CAV S.r.l. has been manufacturing Service control units for industrial use for more than thirty years; this experience has led to a considerable technological Know-how based on many years of R&D activities carried out in tight connection with the product manufacturing and trading on the international market, and this is the best quality guarantee that CAV can offer to users.

### 1.2 POINTS OF SALE AND SERVICE CENTRES

CAV directly offers after-sales service for its products sold in Italy or in Europe.  
(Sales, After-sales, Spare parts)

CAV S.r.l.,  
Via Morandi, 90 - Toscanella di Dozza (Bologna), Italy  
Postal Code 40060  
Phone +39 (0)542 673488  
E-mail: sales@cavitaly.com

Customers are kindly requested to contact the above-indicated central After-sales Service for any doubt or clarification about use, maintenance or request for spare parts. Please remember to specify the Machine identification details that can be found on the nameplates:  
See Nameplate A, paragraph 3.9

### 1.3 CERTIFICATION

The Machine complies with the prevailing European Union Directives applicable at the moment of its release on the market, as detailed in the declaration of conformity.

### 1.4 WARRANTY

Machine components are covered by a 12-month (twelve month) warranty: this period starts from the date indicated on the purchase document (invoice). **Warranty does not cover electrical and electronic parts.** Warranty only covers faulty parts, no labour costs and service call fee.

Warranty excludes any Exhauster damage due to:

- transport and/or handling;
- wrong or improper use of the Machine;
- failed compliance with maintenance specifications given in this Manual; (see paragraph 6.5)
- failures and/or faults not ascribable to faulty parts.

### 1.5 CUSTOMER'S OBLIGATIONS

The Customer shall, within the time frame agreed upon with the Manufacturer, fulfil its obligations indicated in the Documents attached to the sales contract. Unless otherwise agreed, the Customer normally shall take care of:

- Preparing the rooms, including any required building works and/or channels.
- Air supply with compressed air (see paragraph 4.6.1).
- Machine Power Supply, complying with the prevailing rules in the Country of use (see paragraph 4.6.2).



## 1.6 MANUAL LAYOUT

The Customer is required to carefully read this manual since correct pre-setting, installation and use of the Machine are basic requirements for its trouble-free and safe operation.

### 1.6. 1 PURPOSE AND CONTENTS

This manual shall give all necessary information for correct and safe use of the product. It deals with technical information, operation and maintenance details, as well as instructions for spare parts and safety warnings. Before attempting any operation on the machine, operators and qualified technicians are required to carefully read the instructions given herein.

Manual content derives from an ongoing and methodical job of data processing and technical tests filed and approved by C.A.V., complying with the internal safety procedures and data quality rules.

Data herein indicated are **EXCLUSIVELY** for specialised personnel, that could interface with the product under safety conditions for any person, the machine and the environment, carry out a simple troubleshooting and understand strange/faulty operating conditions, carry out simple inspections and maintenance, still fully complying with the instructions given in the following pages and prevailing health and safety regulations.

All details about installation, assembly, removal, extraordinary maintenance, repair and installation procedures for any accessories, devices and equipment, are mentioned and can only be performed by specialised personnel or by the **AUTHORISED AFTER-SALES SERVICE**, fully complying with the manufacturer's recommendations and the prevailing health and safety rules.

It is important to keep this manual in a known place and ensure it is legible, for possible future reference. In case of damage or for further technical and operation details, please contact directly our **AUTHORISED AFTER-SALES SERVICE**.





### 1. 6. 2 MANUAL ADDRESSEES

This Manual addresses both the operator and the technicians allowed to carry out maintenance operations on the machine. Operators shall not carry out any operation reserved to Maintainers or Qualified Technicians. Failure to do so, the Manufacturer will not be liable for any resulting damage.

### 1.6.3 MANUAL STORAGE

This Manual shall be kept next to the Machine and in such a position protected from any fluid or any other condition that could compromise its readability.

### 1.6.4 SYMBOLS

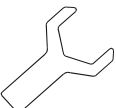
|   |                         |   |
|---|-------------------------|---|
|  | DANGER                  | Indicates a hazard resulting in a (serious) risk for user or any other person.                  |
|  | WARNING                 | Pay utmost attention to the paragraphs highlighted by this symbol.                              |
|  | DANGER OF ELECTROCUTION | Indicates a hazard of electrocution resulting in a (serious) risk for user or any other person. |
|  | SPECIALISED PERSONNEL   | Specialised personnel is required for special operations.                                       |
|  | SEE MANUAL              | It is necessary to refer to the User's Manual before attempting a certain operation.            |
|  | ADJUST                  | Mechanical adjustment and/or electric set-up could be necessary.                                |



## 2 MACHINE DESCRIPTION

### 2.1 PRINCIPLE OF OPERATION

This C.A.V. exhauster is made of a load bearing frame on which mechanical, electromechanical, electronic and pneumatic devices or units are installed and are used, altogether or combined with one another, for suction and filtering of the dust resulting from dry sanding primer or filler/surfacer.

The machine description specifies the intended use for which the product was designed, produced and protected. Any different use or failure to comply with the following specifications could create danger for persons and/or property.

The model described herein consists of some main and auxiliary units, whose functions are listed here below and are aimed at carrying out a production cycle under safety conditions.

Please exclusively contact directly the AUTHORISED AFTER-SALES SERVICE for further details or specifications.

### 2.2 MAIN COMPONENTS

The machine consists of the following main components:

1. Operator control panel
2. Filter holder cylinder
3. Dust collector cylinder
4. Motor guard
5. Bedplate

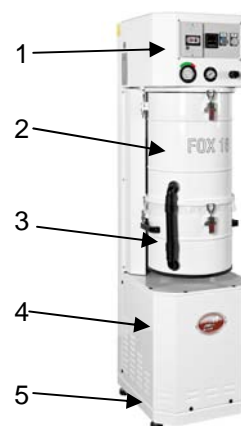

### 2.3 EXHAUSTER STRUCTURE

Unit bedplate and main parts are made of a stiff metal structure. Filtering unit includes dust collection bin. Exhauster is completely enclosed by a front metal guard. A control panel with controls for operation and adjustment is installed in the main electric panel. Power supply connections are realised by means of power and control cables.

### 2.4 DIMENSIONS

Overall dimensions are specified under paragraph 2.9 -Specifications.

### 2.5 AMBIENT CONDITIONS

The Exhauster does not require any special ambient conditions. Nevertheless, it shall be installed in a well-lit industrial building, featuring suitable minimum guaranteed air change.

Ambient temperature for correct unit operation shall be in the range +5°C to +40° C.

### 2.6 LIGHTING

Room lighting shall comply with the prevailing rules in the country where the machine is installed. In the area where the Exhauster is installed, good visibility shall be ensured for easier routine and extraordinary maintenance. Minimum recommended illumination: 400 lux.

### 2.7 VIBRATIONS

If unit is used according to the instructions for correct use, vibrations shall not create any dangerous situation.

### 2.8 NOISE EMISSIONS

The Exhauster is designed and manufactured to limit noise emissions at the source.

**Maximum noise level is 68dB. Actual noise emission shall in any case be measured after installation, in order to ensure that it still conforms to the specifications required by the prevailing laws.**



## 2.9 SPECIFICATIONS

This section indicates Machine technical features and specifications user shall refer to in case of contact with the Manufacturer After-sales Service.

TABLE 2. 9A - Technical Features and Specifications

| Description           | Features                           |
|-----------------------|------------------------------------|
| Power supply          | 400V-415V-50Hz                     |
| Installed power       | Fox 16 - 1.6 kW<br>Fox 22 - 2.2 kW |
| Compressed air supply | Max 10 Bar                         |
| Relative humidity     | Max 90% w/out condensate           |
| Weight (kg)           | 115 - 123                          |
| Dimensions            | 450x540x h1645 mm                  |
| Nominal power input   | Fox 16 - 4.3 A<br>Fox 22 - 5.8 A   |

## 2.10 OUTFIT

The following equipment refers to the standard production Exhausters. Any special machine could hence require parts different than the listed ones.

### 2.10.1 STANDARD

The Exhauster comes with:

- User's Manual
- Declaration of conformity
- Installation equipment

### 2.10.2 OPTION EQUIPMENT ON REQUEST

No options are set with respect to the standard outfit.

Any change and/or addition of any accessory whatsoever must be explicitly approved and made by the Manufacturer.

## 2.11 ELECTROMAGNETIC ENVIRONMENT

The Exhauster is designed to operate correctly within an electromagnetic or industrial environment. Design conforms to the principles of the product Harmonised Technical Standards:

HARMONISED EUROPEAN STANDARD

EN 60439-1(third edition)

February (1995) ref. CENELEC EN 60439-1:1994-01

HARMONISED EUROPEAN STANDARD

EN 60439-1/A1/Ali September (1997) ref. CENELEC EN 60439-1/A1:1995-12+ EN 60439-1/A11:1996-02

In particular, manufacturer used proven components and principles, as required by 7.10 of EN 60439-1/A1:1995-12+ EN 60439-1/A11:1996-02

Built-in electronic equipment was installed as indicated in the instructions that come with the equipment itself and considering the general criteria for **EMC** specified in **EN 60204-1 art. 4.**

HARMONISED EUROPEAN STANDARD EN 60439-1(third edition)

February (1995) ref. CENELEC EN 60439-1:1994-01

HARMONISED EUROPEAN STANDARD EN 60439-1/A1/Ali

September (1997) ref. CENELEC EN 60439-1/A1:1995-12+ EN 60439-1/A11:1996-02

In particular, manufacturer used proven components and principles, as required by 7.10 of EN 60439-1/A1:1995-12+ EN 60439-1/A11:1996-02

Built-in electronic equipment was installed as indicated in the instructions that come with the equipment itself and considering the general criteria for **EMC** specified in **EN 60204-1 art. 4.**



### 3 SAFETY RULES

#### 3.1 GENERAL WARNINGS

The Operator shall carefully read the information given in this Manual, especially the Safety rules and precautions specified in this section.

Moreover, it is fundamental that the Operator follows these warnings:

- keep the Exhauster and the work area clean and in order;
- use the Exhauster in normal psychophysical conditions;
- wear appropriate clothes and personal protection gear suitable for products in use;
- do not remove or tamper with the Manufacturer nameplates on Exhauster;
- do not remove or make inoperative any of the Exhauster Safety systems.
- **Do not use this unit in rooms subjected to risk of explosion.**

#### 3.2 INTENDED USE

The Exhauster is designed for removing non-explosive dust in general or similar material.

#### 3.3 UNSUITABLE USE

Do not use the Exhauster:

- for different purposes than those indicated in 3.2;
- to take in substances that could result in a flammable and/or explosive environment;
- in environments featuring explosive, aggressive atmosphere or with high dust or oily content;
- in environments with a serious fire hazard;
- outdoors, exposed to any weather condition;
- to take in red-hot parts and/or parts on fire;
- in a different way than stated in safety installation rules given herein.

#### 3.4 DANGEROUS AREAS

Although the Exhauster does not involve any particular danger for exposed persons, it shall be used taking some precautions, considering that:

- the operator can come into contact with dangerous chemical products by accident and without being aware of the resulting danger.
- Before use, the person in charge of production shall evaluate unit use conditions according to the danger possibly caused by products and take suitable protections such as: work in a room featuring a guaranteed minimum ventilation or change of air.
- **Pay utmost attention when removing the dust bag. Carefully follow the filter removal procedure described in the manual and shown in the figures on the package.**
- Exhaust tube and silencer could reach a very high temperature (>55°C) so it is important that users wear any necessary safety gear before starting any operation.

#### 3.5 SAFETY DEVICES

The Exhauster comes complete with suitable guards to protect the persons exposed to risks due to moving organs, risks connected to power supply, and so on.

The unit fits the following safety devices:

- metal barrier all around the mobile parts. Basically, the enclosures are a barrier for any potentially dangerous parts.
- The emergency stop is performed via the control panel main switch.
- Main switch cuts off machine supplies to perform maintenance under safety conditions.
- Safety release on the levers for removing the dust collector cylinder metal body.

The User is requested to install the following safety devices:

- **Electrical equipment with TT system:** automatic circuit breaker with differential protection against direct and indirect contacts on machine power control panel (if activated, it causes uncontrolled stop of all actuators and power cut-off);
- **Electrical equipment with TN or IT system:** refer to control panel specifications to install the suitable protections.



### 3.6 STOP CONTROLS

The Exhauster stop controls are:

- main power cut-out by Main Switch (to set unit out of service located on control panel installed by the Customer);
- Button knife switch incorporated in **power control panel** that, when activated, cuts power to both auxiliary and power circuits;
- Controlled stop due to opening of the run enable auxiliary contact (e.g. suction mouthpiece Open / Closed).

### 3.7 SAFE WORKING PROCEDURES

The Exhauster design features aim at eliminating all risks connected to its use.

The residual risks involved in operating mode are:

- risks connected with the use of pneumatic energy;
- risks connected with the use of electric energy;
- risks of possible contact with product removed by suction;
- risks of possible contact with hot surfaces.

To limit the consequences of such dangers as much as possible, it is important to comply with the following rules:

- Ensure that air supply pressure is available and set to specified value: **max. 10 bars**;
- Do not start the Exhauster before checking the correct installation and parameters set at operator panel; this can be done by running a cycle with no product to be taken in by exhauster;
- Wear the personal protection gear suitable for the product in use;
- Wear clothes with close-fitting sleeves.

### 3.8 RESIDUAL RISKS

During the normal suction cycle and during maintenance, the Operators can run some residual risks that can not be completely avoided, due to the type of operation being performed, such as danger of electrocution, noise and contact with hot surfaces (indicated by suitable warning plate).

### 3.9 NAMEPLATES

Table 3. 9A - Types of Nameplates

Nameplates on the Exhauster fig.3.9.A











|   |   |               |               |  |    |  |   |             |       |  |    |  |                   |  |      |  |              |  |                             |     |   |  |  |  |   |
|---|---|---------------|---------------|--|----|--|---|-------------|-------|--|----|--|-------------------|--|------|--|--------------|--|-----------------------------|-----|---|--|--|--|---|
| Nameplate "A"   | Nameplate "B"   | Nameplate "C" | Nameplate "D" |  |    |  |   |             |       |  |    |  |                   |  |      |  |              |  |                             |     |   |  |  |  |   |
| <table border="1" style="width: 100%; border-collapse: collapse;"> <tr> <td colspan="2" style="text-align: center;"> <br/>           Via R. Morandi, 93 - 40060 TO SCANELLA<br/>           BOLOGNA ITALY<br/>           Tel. 0542-673488 Fax: 0542-672065         </td> </tr> <tr> <td colspan="2">MOD.</td> </tr> <tr> <td colspan="2">KW</td> </tr> <tr> <td style="width: 50%;">A</td> <td style="width: 50%;">MASSA<br/>Kg</td> </tr> <tr> <td colspan="2">VOLTS</td> </tr> <tr> <td colspan="2">Hz</td> </tr> <tr> <td colspan="2">M<sup>3</sup>/h</td> </tr> <tr> <td colspan="2">Mbar</td> </tr> <tr> <td colspan="2">MATRICOLA N.</td> </tr> <tr> <td style="width: 50%;">MISE<br/>ANNO<br/>COSTRUZIONE</td> <td style="width: 50%;">200</td> </tr> <tr> <td colspan="2" style="text-align: center;">  </td> </tr> </table> | <br>Via R. Morandi, 93 - 40060 TO SCANELLA<br>BOLOGNA ITALY<br>Tel. 0542-673488 Fax: 0542-672065 |               | MOD.          |  | KW |  | A | MASSA<br>Kg | VOLTS |  | Hz |  | M <sup>3</sup> /h |  | Mbar |  | MATRICOLA N. |  | MISE<br>ANNO<br>COSTRUZIONE | 200 |  |  | <br> | <br><br> | <br><br><br><br> |
| <br>Via R. Morandi, 93 - 40060 TO SCANELLA<br>BOLOGNA ITALY<br>Tel. 0542-673488 Fax: 0542-672065   |   |               |               |  |    |  |   |             |       |  |    |  |                   |  |      |  |              |  |                             |     |   |  |  |  |   |
| MOD.  |   |               |               |  |    |  |   |             |       |  |    |  |                   |  |      |  |              |  |                             |     |   |  |  |  |   |
| KW  |   |               |               |  |    |  |   |             |       |  |    |  |                   |  |      |  |              |  |                             |     |   |  |  |  |   |
| A   | MASSA<br>Kg   |               |               |  |    |  |   |             |       |  |    |  |                   |  |      |  |              |  |                             |     |   |  |  |  |   |
| VOLTS   |   |               |               |  |    |  |   |             |       |  |    |  |                   |  |      |  |              |  |                             |     |   |  |  |  |   |
| Hz  |   |               |               |  |    |  |   |             |       |  |    |  |                   |  |      |  |              |  |                             |     |   |  |  |  |   |
| M <sup>3</sup> /h   |   |               |               |  |    |  |   |             |       |  |    |  |                   |  |      |  |              |  |                             |     |   |  |  |  |   |
| Mbar  |   |               |               |  |    |  |   |             |       |  |    |  |                   |  |      |  |              |  |                             |     |   |  |  |  |   |
| MATRICOLA N.  |   |               |               |  |    |  |   |             |       |  |    |  |                   |  |      |  |              |  |                             |     |   |  |  |  |   |
| MISE<br>ANNO<br>COSTRUZIONE   | 200   |               |               |  |    |  |   |             |       |  |    |  |                   |  |      |  |              |  |                             |     |   |  |  |  |   |
|    |   |               |               |  |    |  |   |             |       |  |    |  |                   |  |      |  |              |  |                             |     |   |  |  |  |   |

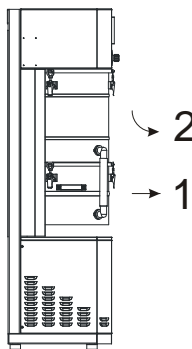
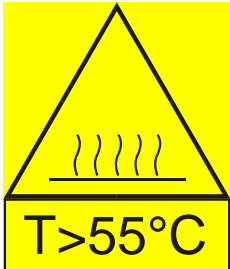

Figure 3. 9 B - Nameplates position

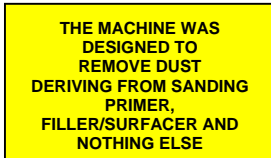

|  |  |
|--|--|
|  | <p><b>WARNING!</b><br/>THE SAFETY WARNING NAMEPLATES SHALL NOT BE REMOVED, COVERED OR DAMAGED.</p> |
|--|--|

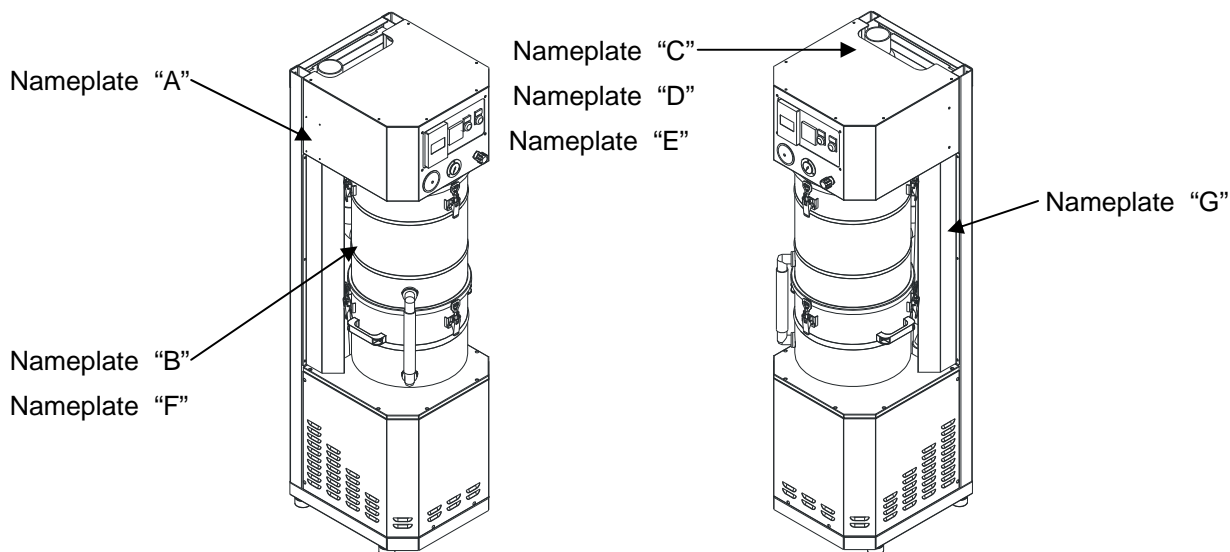
#### 4 INSTALLATION

##### 4. 1 TRANSPORT AND HANDLING

Have unit transported by qualified and trained Personnel. The Exhauster shall be handled in a suitable way so as to avoid damages. All protections, electric circuits, control equipment, shall be suitably closed and fastened.

**The Exhauster is packed on pallet, wrapped in plastic and covered with cardboard.** Packed machine dimensions and weight are indicated on the package. Check for transport damages together with the carrier.

**N.B.: The Manufacturer will not be liable for damages due to improper lifting and handling of the packed unit.**

|  |   |
|--|---|
|  | <p>WARRANTY does not cover any damage to the Exhauster due to transport and handling.<br/>Any repair or replacement of damaged parts is at the Customer's charge.</p> |
|--|---|

##### 4. 2 STORAGE

For any long period of inactivity, store the Exhauster in a suitable place, considering storage environment and time. In particular, consider allowed temperature range, humidity and pollution.

- Store the Exhauster indoors;
- Protect the Exhauster from any shock and stress;
- Protect the Exhauster from humidity and extremely wide temperature ranges +0° C + 60 °C;
- Avoid contact with corrosive substances.

##### 4.3 ARRANGEMENTS BEFORE INSTALLATION

Before installation, it is necessary to prepare a suitable operating area, limiting any interference with other activities as much as possible.



#### 4.4 ASSEMBLY

Exhauster can be assembled either by the technicians authorised by the manufacturer or directly by the customer, following these steps:

##### Unpacking.

**Remove** all packing material from the machine, using suitable tools and setting it in a suitable place. Dispose of the packing material according to the prevailing environment protection regulations.

(Visually) **check** machine external parts for damage, carefully ensure that there are no scratches, denting or damaged parts.

**Report** any fault, failure or missing parts found within five days from machine arrival. Beyond this term the Manufacturer is no longer liable for the machine supplied.

#### WARNINGS AND PRECAUTIONS for installation

Always start by checking correct operation, assembly and efficiency of controls and safety systems. **In case** you find operating faults, immediately stop the machine and contact the AUTHORISED AFTER-SALES SERVICE. **Pay attention** to the adhesive nameplates on the machine. Should they become damaged or illegible, promptly change them. For this operation contact the AUTHORISED AFTER-SALES SERVICE or the Manufacturer. Have **any maintenance intervention** -as per the definition of "user" given in the foreword section- performed by qualified personnel. **Using spare parts** that do not comply with the following specifications, any change or tampering (though small as they may be) relieve the Manufacturer of any liability concerning the correct use, operation and safety of persons and/or property. **It is strictly forbidden** to tamper with equipment, control organs and safety devices. **Dispose of waste** as required by the prevailing laws. **If the machine is used by many operators**, all of them shall read the instructions for use and indicate any maintenance intervention or parts replaced, or just suspected faults on the servicing data sheet.

#### 4.5 SET-UP

Set Exhauster and filtering unit on a flat and clean surface and ensure that the equipment and tools for machine mechanical set-up are in place.

To handle the machine under safety conditions, lift it by means of a fork lift truck. After setting the machine in position, level it and tighten the lock nuts to ensure it stays firmly in place.

Fix the machine by using the holes on the rear bracket (A), to assure stability.

**N.B.: It shall always be possible to work all around the machine for maintenance purposes. Ensure there is enough room in this area upon installation.**

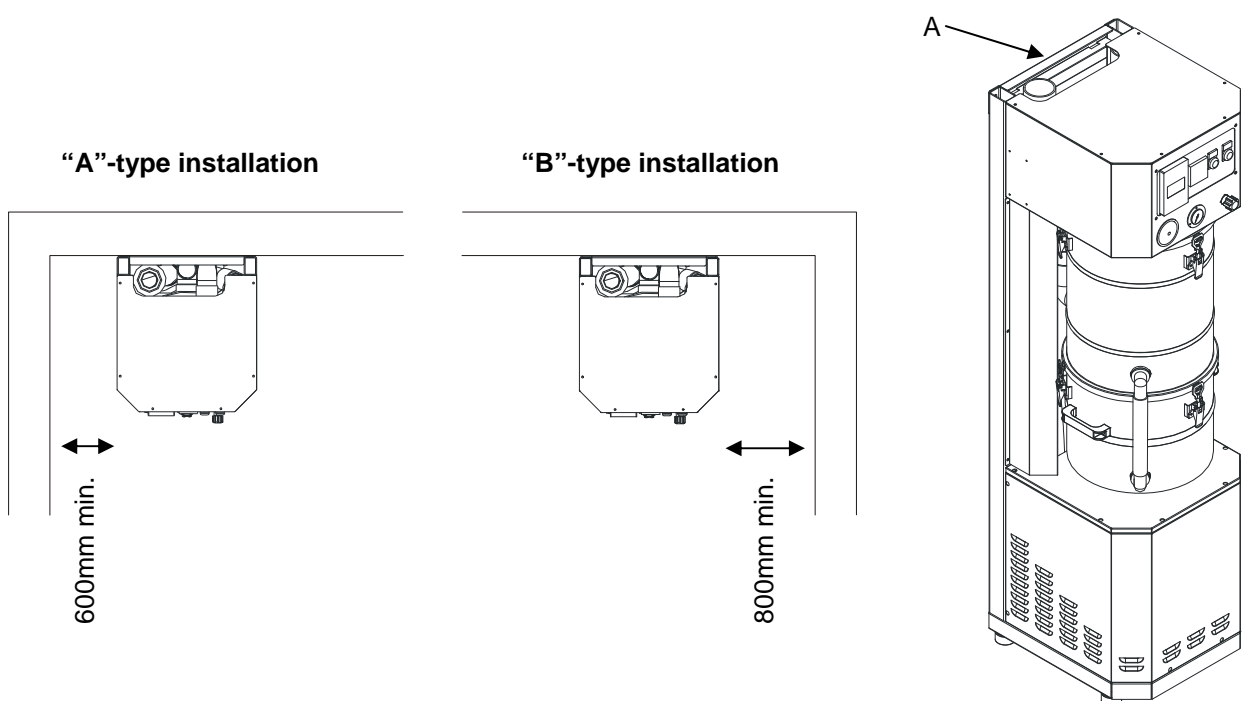

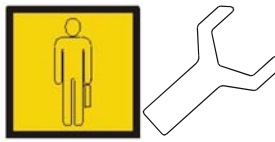

## 4.6 CONNECTIONS

To avoid any problem upon Exhauster start-up, follow the instructions below.

### 4.6.1 PNEUMATIC CONNECTIONS

Figure 4. 6. 1A- Pneumatic System Layout

Connection to the air supply is ensured by a flexible hose secured with screw clamps.

The mobile connection is supplied together with the Exhauster.

The standard Exhauster comes with regulator unit.

Air supply requirements:

- Operating pressure: 5 bars
- Maximum pressure: 10 bars

Connect compressed air supply to the supplied tube, by inserting a gate valve (to be supplied by Customer) on the pre-set line so that the supply can be cut off during maintenance. It is strongly recommended to feed the machine with dry compressed air.

**Compressed air of the supply line must be completely dry, i.e. treated upstream of the exhauster. It is recommended to install a 5 micron air filter.**





#### 4.6.2 ELECTRIC CONNECTIONS

Figure 4. 6. 3A- Electric System Layout

##### POWER SUPPLY

Exhauster electrical connections are at the Customer's charge, under its own responsibility. The electrical connections of the Exhauster shall consider:

- the Laws and Technical standards applicable at the time of installation in the place of installation;
- data indicated on " Nameplate A ".

Make the electrical connections.

Supply power to the machine with a separate line of suitable cross-section, also providing suitable protections for direct and indirect contact. **This line and its protections are at the Customer's charge (see page 7).**

- Power cord is with double insulation and of suitable 2.5 mm<sup>2</sup> cross-section (approx. 3m long) and completed with ground wire;
- control cable or for remote starting shall have a section of 2x1.5 sq.mm (approx. 3m long) and shall be connected to electric item microswitch line.



The electrical system design and components ensure utmost dependability and safety of use. The attached wiring diagrams will allow identification of all connections and components. Only make the required electrical connections; do not modify any circuits, calibrations, components, etc. Failure to follow this warning will be considered as tampering. Before connecting to the mains, ensure that power voltage and frequency correspond to the specifications indicated on the nameplate. **Perform ground connections and/or zero setting as required by the prevailing laws of the country.**



#### 4.6.3 SUCTION

After positioning the exhauster and the filtering unit, connect the Ø63 mm fitting located on filter holder cylinder (B) to an antistatic flexible hose deriving from the main suction line.

Remove the side protections (A) to carry out this operation. "Peel" the copper wire and fold it inward (if tube is grounded) or connect it to a ground or bonding lead. Fasten the hose with its metal clamp.

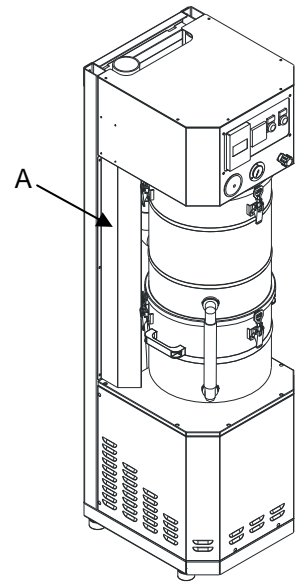

#### 4.6.3a OUTLET

Set outlet lines having a minimum diameter of 80mm. It is necessary to install, in-between silencer (C) and outlet line, a rubber hose to allow for silencer removal and maintenance. **Important: The outlet lines weight must not lie on silencer.**

#### 4.7 PRELIMINARY INSPECTION

Power supply, compressed air supply and Exhauster preparation stages for commissioning do not require any special knowledge apart from those acquired after reading this manual.

Before starting up the Machine it is necessary to perform some inspections and checks in order to avoid errors or accidents:

- ensure that the Exhauster did not suffer any damage during assembly;
- pay special attention when checking electrical parts, control panels, cables and air lines;
- check that all external supplies connections are correct;
- ensure that all mobile parts can move freely.

#### 4.8 ADJUSTMENTS AND CHECKS

The Exhauster is tested at the Manufacturer's premises, before shipment. No further adjustment is necessary.

When starting the Exhauster for the first time, proceed as follows:

- set the Main switch QSI lever to ON (**switch is installed by the Customer**);
- open compressed air supply cock; ensure that compressed air regulator reads 5 bars;
- Activate the machine main switch;
- after being supplied, the Exhauster sets to automatic operation mode. Only the voluntary closure of the remote starter contact can start the machine.

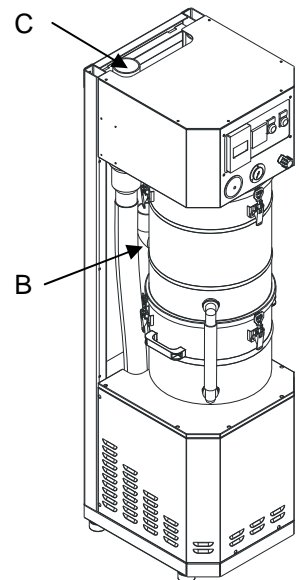



## 5 OPERATION

### 5.1 PERSONNEL

The Exhauster is designed for use by many Operators.

Personnel allowed to work on the Exhauster shall have the following knowledge (or acquire it after suitable training) and be familiar with the contents of this Manual as well as all Safety-related concerns:

- General and technical knowledge of suitable level to understand Manual contents;
- Knowledge of the main health and safety and accident prevention rules;
- Knowledge of how to behave in an emergency situation, where to find personal protection gear and how to use it correctly.
- Maintainers, apart from the above, shall also have suitable electrical, pneumatic and mechanical Technical knowledge.

### 5.2 CONTROL PANEL

Exhauster controls are on the control panel, at Machine front.

Figure 5.2 a - controls on front panel

KEY:

1. Panel main switch;
2. Hour counters;
3. Power on warning light;
4. Manual filter cleaning button.

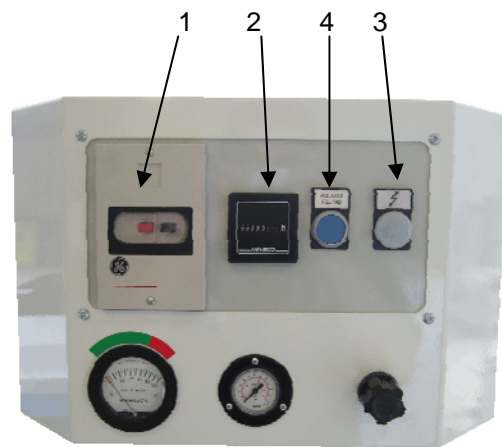

### 5.3 COMMISSIONING AND USE

To power on the Exhauster proceed as follows:

1. set Main Switch to ON to set the machine ready to start;
2. open compressed air supply cock;
3. when one of the suction mouthpieces opens, so that the remote contact closes, the machine starts and performs set function, as pre-programmed at the Factory with default settings, that are usually suitable for normal use.



## 5.4 OPERATING MODES

After commissioning you can use the machine, no operator intervention is necessary.

## 5.5 JOB END

The procedure for a voluntary Stop is as follows:

1. Open the main switch on control panel QSI installed by the customer (OFF position);
2. Open the main switch on machine control panel;
3. Close compressed air supply cock.

## 5.6 DECOMMISSIONING

In case of long periods of inactivity or **in case of maintenance, user shall compulsorily:**

- Open and padlock the main switch QSI on main control panel (see Figure 6.1 A);
- Close and lock compressed air inlet valve (see Figure 6.1.B);
- Release circuit air by opening the condensate drain cock;
- Put out a panel reading "EXHAUSTER BEING SERVICED".

## 6 MAINTENANCE

### 6.1 EXHAUSTER CUT-OFF

Before attempting any maintenance or repair job, user must cut all Exhauster supplies, proceeding as follows:

1. Open and padlock the main switch on main control panel (6.1A).
2. Close and padlock the compressed air supply and open the condensate drain cock to drain the system (6.1B).

6.1A

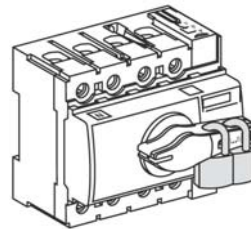

6.1B

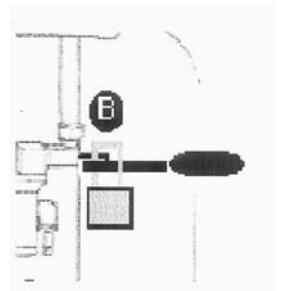

### 6.2 SPECIAL PRECAUTIONS

When carrying out maintenance or repair jobs, it is recommended to proceed as follows:

- Before starting, put out a panel reading "EXHAUSTER BEING SERVICED" in a visible position.
- Do not use solvents and flammable materials;
- Do not release lubricants into the environment;
- Machine parts are not designed to bear a person's weight; do not stand on them or they could break.
- When job is completed, restore and correctly fasten all protections and guards previously removed or opened, as well as any safety device, if previously disabled.



### 6.3 PARTS SUBJECT TO ROUTINE MAINTENANCE

Maintenance shall be carried out with the Exhauster set out of service for replacement of damaged or worn parts. The Exhauster does not require frequent maintenance. If compressed air does not meet indicated requirements, the following could get damaged:

1. Pressure regulator
2. Solenoid valve
3. Filter cartridge
4. Dedusting device
5. Condensate drain

Should cartridge fail and break, this could damage the turbine unit (6) and the silencer (7).

1) Remove the regulator:

- close air feed;
- release any residual air by opening the condensate drain cock;
- remove the upper cover;
- remove the control panel, by loosening the four screws on the machine front part;
- disconnect the lines, loosen and remove the regulator;
- clean/change and refit the regulator;
- reassemble by following the reverse procedure.
- Restore 5 bar pressure.

2) Replace solenoid valve if it jams. Change as follows:

- Close air feed;
- Release any residual air by opening the condensate drain cock;
- remove the upper cover;
- remove the connector by undoing the retaining screw;
- remove the connecting tube;
- remove the bottle by unscrewing it from the support;
- unscrew the solenoid valve;
- clean and/or change the solenoid valve;
- reassemble by following the reverse procedure.

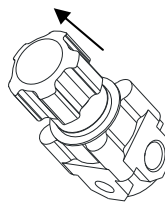
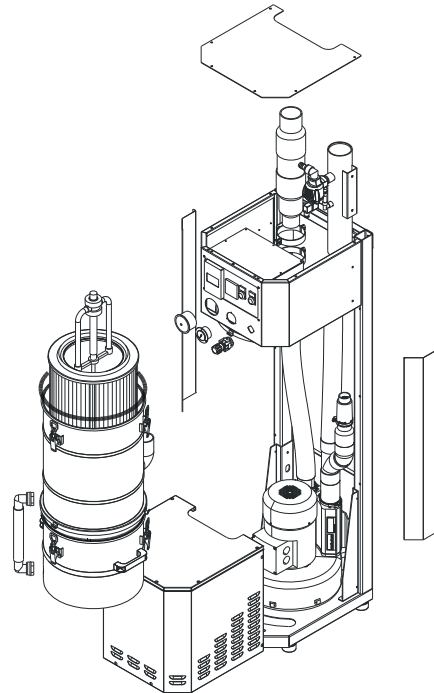



### 3) Filter cartridge

- Cut off power and air supply (see relevant procedures in the previous pages);
- remove the "A" protection;
- disconnect Ø63 inlet tube from inlet manifold;
- remove the dust collector cylinder;
- remove the filter holder cylinder;
- loosen nut under cartridge;
- set the new cartridge in place, ensuring to set it at the centre and that the seal correctly sets against the plate;
- tighten the nut, do not squeeze seal too much (nut finger tight + two turns);
- refit the filter holder cylinder;
- refit the dust collector cylinder;
- refit the vacuum connection line between the two cylinders (C).
- Reconnect the Ø63 tube;
- refit the "A" protection.

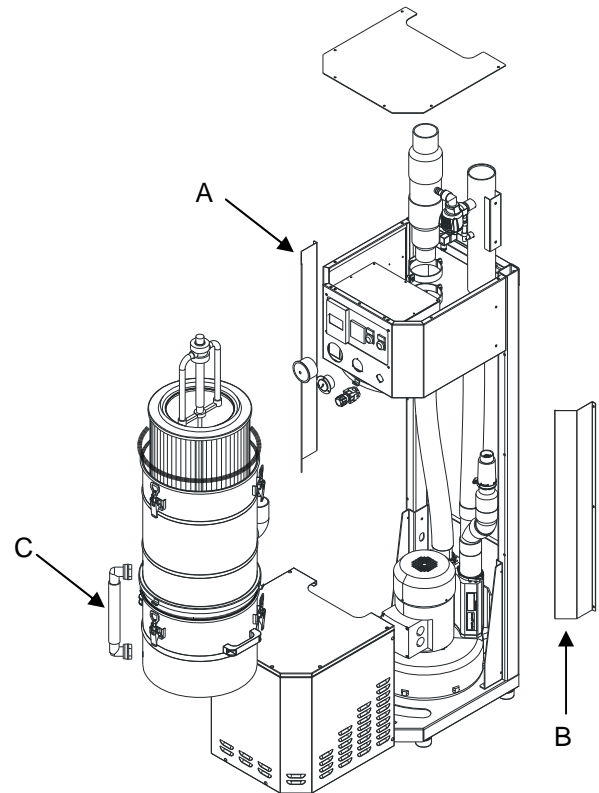

### 4) Dedusting device

- Cut off power and air supply (see relevant procedures in the previous pages);
- Proceed as described in step 3 until removing the filtering cartridge;
- Loosen the dedusting device and renew it;
- Reassemble as indicated in item 3.

### 5) Condensate drainage

- Remove the "B" protection;
- release the condensate in a collector;
- refit the "B" protection.

**Important: dispose of the condensate as required by the prevailing rules!**

### 6) Motor

- **Cut off power** and air supply (see relevant procedures in the previous pages);
- Contact Authorised After-sales Service.

### 7) Silencer

- **Cut off power** and air supply (see relevant procedures in the previous pages);
- remove the upper cover;
- remove the "A" protection;
- Remove the silencer unit, **ensuring no foreign objects can fall inside the turbine outlet tube;**
- Blow compressed air at 6 bars inside the silencer;
- reassemble by following the reverse procedure.



### 6.4 CLEANING

It is recommended to frequently clean the whole Machine (intervals depend on type and frequency of use). Use a soft rag. Do not use water and/or solvents.

- **Monthly** clean inside the machine to ensure motor cooling efficiency.
- **Changing the bag.** It is impossible to set a standard interval for replacing the dust collector bag so it is important to frequently check dust quantity during the first two weeks of use. Periodically empty the bag according to the work you do. Release the three levers to unlock the dust collector cylinder. Disconnect the vacuum tube and remove the cylinder by pulling the two side handles. Pull out the nylon bag and close it. Fit a new bag, ensure it adheres to cylinder walls. Turn over bag exceeding length on cylinder edge. Refit the dust collector cylinder and engage the three levers. **Important!** Refit and ensure that the vacuum tube does not leak. Any leak (though small as it may be) will move the nylon bag up toward the filter cartridge, thus blocking off the machine suction opening, and finally break the bag. It is necessary to dispose of the collected dust according to the prevailing laws of the country where machine is installed.



### 6.5 ROUTINE MAINTENANCE

The following operations shall be performed at the indicated time intervals. Failure to comply with this schedule will relieve the Manufacturer of any liability or warranty obligation.

These operations, though simple as they may be, shall be carried out by **suitably trained and expert Personnel**.

Scheduled routine maintenance includes inspections, tests and interventions aiming at preventing system stoppage due to faults or potentially dangerous situations.

### 6.6 EXTRAORDINARY MAINTENANCE

Extraordinary maintenance is an activity reserved to personnel appointed by the manufacturer or the manufacturer itself. Please contact the centres specified under paragraph 1.2 in case of need. **Considering the machine routine maintenance, the intervention of a technician for extraordinary maintenance is highly unlikely, unless for special cases or when expressly requested.**

| MAINTENANCE                 | DESCRIPTION   | INTERVENTION   |
|-----------------------------|---|--|
| Pneumatic System            | Valves and tubes/lines  | No scheduled maintenance required.                               |
| Pneumatic System            | Condensate drain  | Weekly   |
| Electrical System           | Control Panel   | No scheduled maintenance required.                               |
| Suction System              | Filter  | Change every 2000 hours or when head loss exceeds 70/80 mmH2O.   |
| Turbine Motor               | Bearings. Have bearings changed by an Authorised Service Centre.                                  | Change every 15,000 hours.                                       |
| Motor compartment           | Clean carefully.  | Monthly.   |
| Dust collector bags         | Change.   | When necessary.  |
| Tighten power wiring screws | Tighten screws and junctions<br><b>PLACE UNIT OUT OF SERVICE BEFORE PERFORMING THIS OPERATION</b> | Perform 3 months after installation and repeat every six months. |



## 7 DIAGNOSTICS

### 7.1 TROUBLESHOOTING

Table 7.1 A

| TROUBLE  | CAUSE   | INSPECTION AND/OR FIX   |
|--|---|---|
| Dust is coming out of the silencer   | <ul style="list-style-type: none"> <li>Faulty filter cartridge</li> <li>Worn seal</li> </ul>  | <ul style="list-style-type: none"> <li>Change filter cartridge</li> <li>Change filter cartridge</li> </ul>  |
| The solenoid valve or regulator "hiss"   | <ul style="list-style-type: none"> <li>Poor air quality, dirty membranes</li> <li>Membrane failure</li> </ul>   | <ul style="list-style-type: none"> <li>Install air filter at inlet</li> <li>Clean/change regulator/solenoid valve</li> </ul>  |
| The motor is not starting  | <ul style="list-style-type: none"> <li>No power supply from the mains</li> <li>Thermal cut-out enabling</li> </ul>  | <ul style="list-style-type: none"> <li>Check power supply</li> <li>Reset the main switch</li> </ul>   |
| The motor stops  | <ul style="list-style-type: none"> <li>No power supply from the mains</li> <li>Motor overload</li> </ul>  | <ul style="list-style-type: none"> <li>Check power supply</li> <li>Check dedusting device and filter cartridge operation</li> <li>Check the vacuum breaker valve operation (only Fox 22)</li> </ul>   |
| Filter is not automatically cleaned  | <ul style="list-style-type: none"> <li>No compressed air feed</li> <li>Dedusting device is stuck</li> <li>Faulty timer</li> <li>Faulty solenoid valve</li> </ul>  | <ul style="list-style-type: none"> <li>Restore compressed air feed</li> <li>Clean/change dedusting device</li> <li>Change timer</li> <li>Clean/change the solenoid valve</li> </ul>   |
| Faulty or insufficient suction   | <ul style="list-style-type: none"> <li>Filter clogged due to failure of emptying dust collector bag</li> <li>Damp filter</li> <li>Suction of objects</li> <li>Dedusting device is stuck</li> <li>Faulty solenoid valve</li> <li>Faulty timer</li> <li>No compressed air feed</li> </ul> | <ul style="list-style-type: none"> <li>Empty dust collector bag more frequently, an excessive quantity of accumulated dust clogs the filter cartridge</li> <li>Check for condensate in the machine accumulation tank. Install a filter at machine inlet</li> <li>Disconnect the Ø63 tube from the filter holder cylinder and check the machine suction setting. If suction is correct, system took in something that jams air passage in tube. Remove jamming.</li> <li>See above</li> <li>See above</li> <li>See above</li> <li>See above</li> </ul> |
| With openings open, differential pressure gauge displayed pressure is considerably different from zero | <ul style="list-style-type: none"> <li>Clogged filter</li> <li>Clogged/broken connecting tubes</li> <li>Broken pressure gauge</li> </ul>  | <ul style="list-style-type: none"> <li>See above</li> <li>Clean the connecting tubes and reconnect them to pressure gauge</li> <li>Renew the pressure gauge</li> </ul>  |

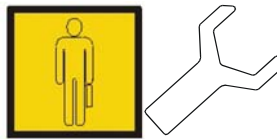

## 7.2 AFTER-SALES SERVICE

The Manufacturer is always willing to answer Customer's questions and give information on use, maintenance or installation and so on. Please follow the instructions given under paragraph 1.2 on how to request our assistance.

## 8 SPARE PARTS

### 8.1 SPARE PARTS LIST

Exhauster use does involve some expendable parts. Following is the list of available spare parts and expendable parts.

Table 8.1- A

| POS. | DESCRIPTION                        | PART NO.                            |
|------|------------------------------------|-------------------------------------|
| 1    | Side-channel blower                | Fox 16: K15-41-S<br>Fox 22: K22-1-S |
| 2    | Solenoid valve                     | A: 9029<br>B: 9018                  |
| 3    | Pressure regulator                 | PCX-0001                            |
| 4    | Pressure gauge                     | 35-56                               |
| 5    | Silencer                           | SIL-10                              |
| 6    | Differential pressure gauge        | 8153                                |
| 7    | Dedusting device                   | K2-0080                             |
| 8    | Filter cartridge                   | K2-91-Allum                         |
| 9    | Top seal                           | 7860-0106                           |
| 10   | Bottom seal                        | 7867-0106                           |
| 11   | Dust collection bag                | 99988                               |
| 12   | Vacuum breaker valve (only Fox 22) | V.L.P. 22                           |



## **8.2 ORDERING SPARE PARTS**

We remind you that the machine can only be repaired by a qualified technician.

It is hence recommended to contact the Manufacturer After-sales Service that will make available Qualified Personnel, suitable equipment and original spare parts.

To order above-listed spare parts, please refer to paragraph 1. 2

## **9 SCRAPPING**

### **9.1 DISPOSING OF WASTE**

During processing, waste or rejections are created that shall be collected, recycled or disposed of, in compliance with the prevailing laws of the country where the Machine is installed.

### **9.2 MACHINE SCRAPPING**

Upon unit scrapping, separate the plastic parts from any electrical components, that shall be sent to different waste disposal centres, as per prevailing rules.

The machine metal parts shall be divided into steel and other metals or alloys, and then routed to recycling firms.

Unit scrapping does not cause any special risk, as far as it is performed by qualified personnel with suitable equipment.

## **10 ANNEXES**

### **10.1 DECLARATIONS**

The following Declarations are hereby attached:

- Declaration of conformity.

### **10.2 DIAGRAMS**

The following Diagrams are hereby attached:

- Electric circuit diagram and key;
- Pneumatic circuit diagram;
- Machine exploded view.



# Electric circuit diagram

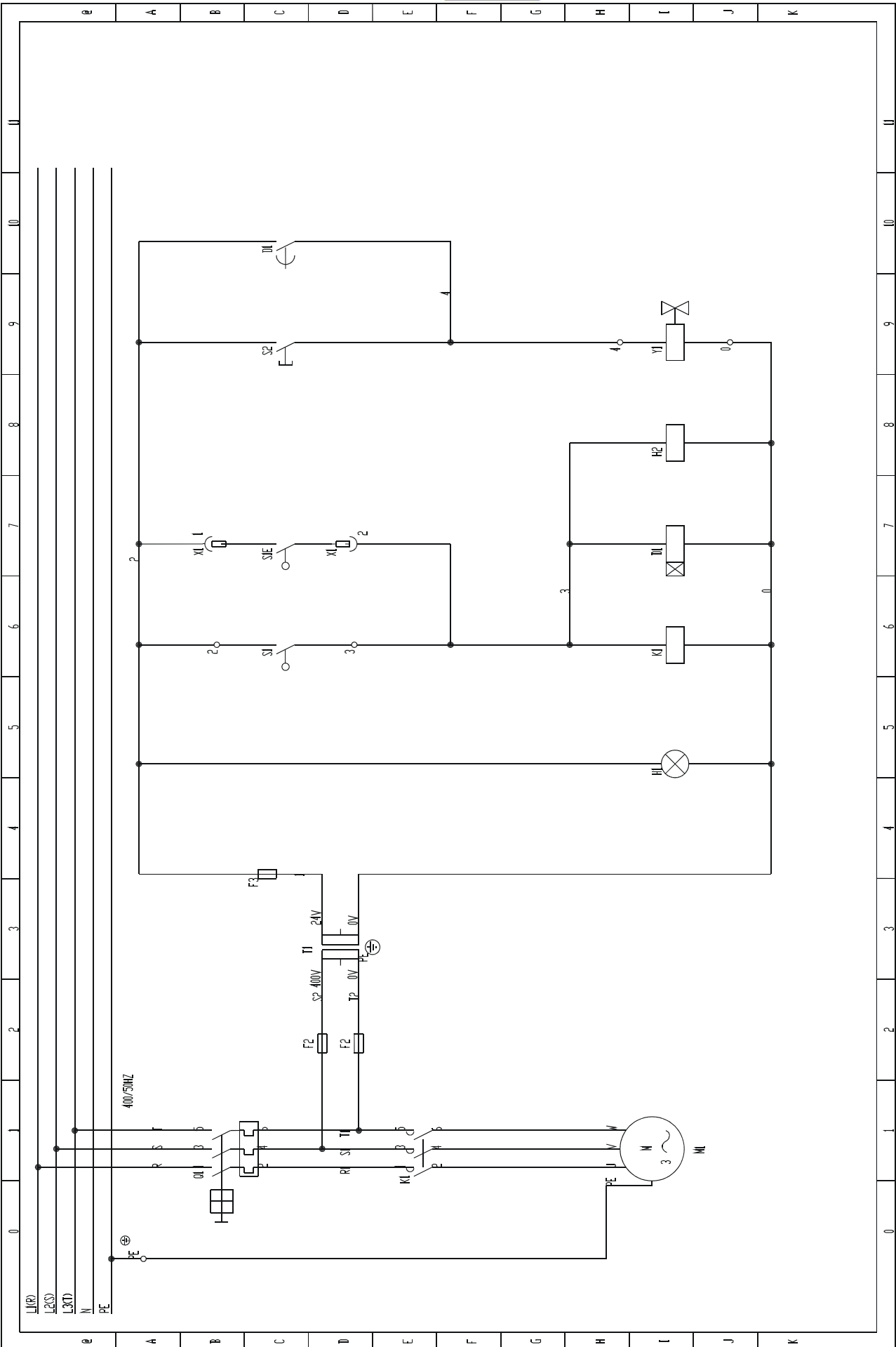

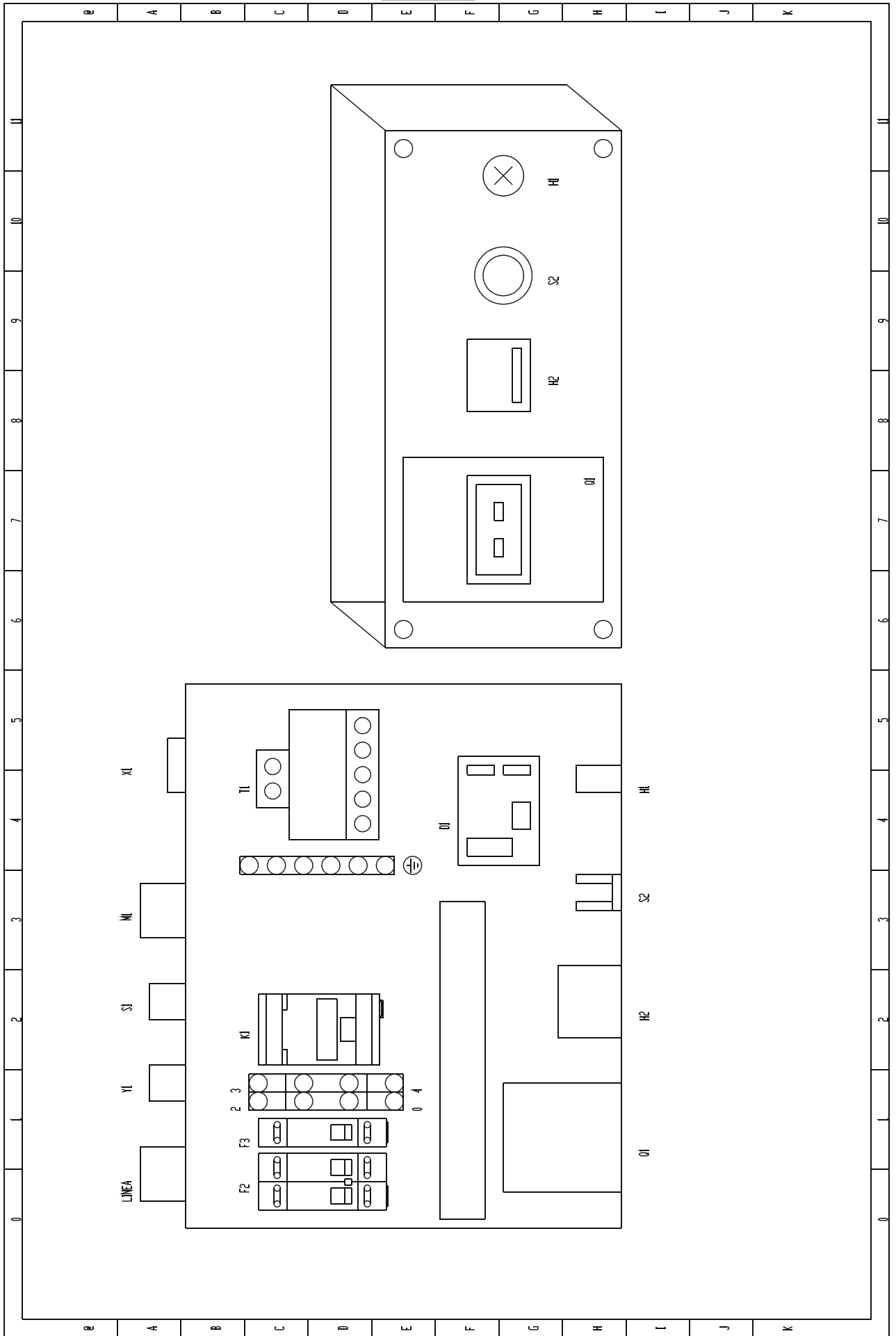



**List of components - control panel**

| ID | Description                | Manufacturer - Specs. | Part no.                 |
|----|----------------------------|-----------------------|--------------------------|
| Q1 | Main switch                | CGE                   | SKFOI 4-6.3A             |
| F2 | Auxiliary fuses            | Elettritalia          | 10x38 - 0.5A Am          |
| F3 | Auxiliary fuses            | Elettritalia          | 10x38 - 2 A              |
| T1 | Transformer                | Elma                  | Elma 7 0-230-400/0-12-24 |
| K1 | Contactor                  | Moller                | DILM12-01-24V            |
| D1 | Timer                      | Elcotec               | GV05                     |
| S1 | External start microswitch |                       |                          |
| S2 | Filter cleaning button     | Moller                | M22-D-B                  |
| H1 | Line lamp                  | Moller                | M22-LC-W                 |
| Y1 | Solenoid valve             |                       |                          |
| H2 | Hour counter               | Revalco               | HK46024                  |

**Pneumatic circuit diagram**

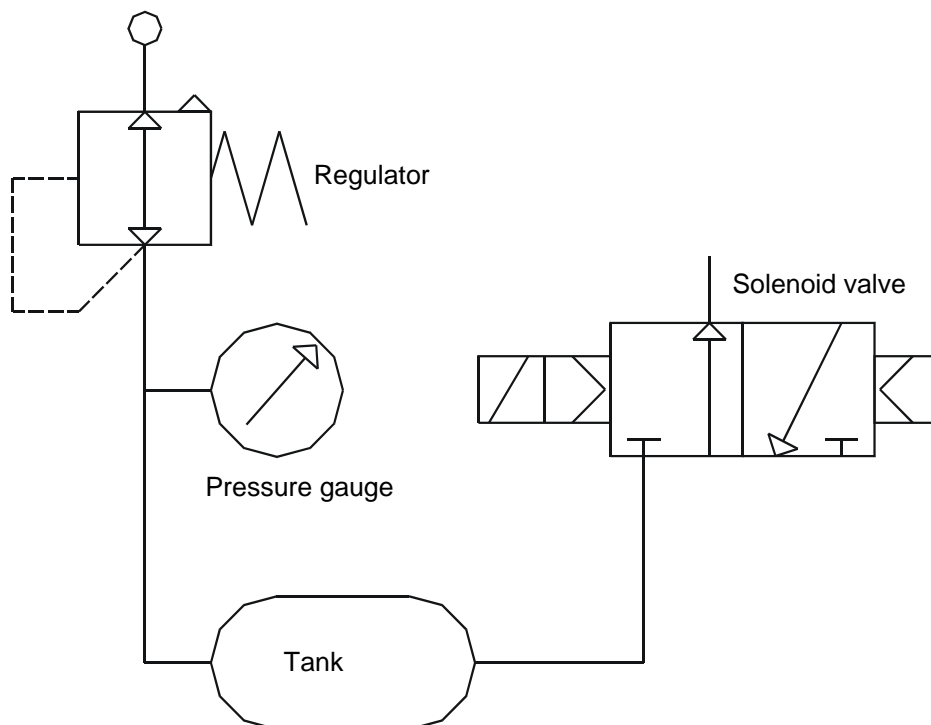

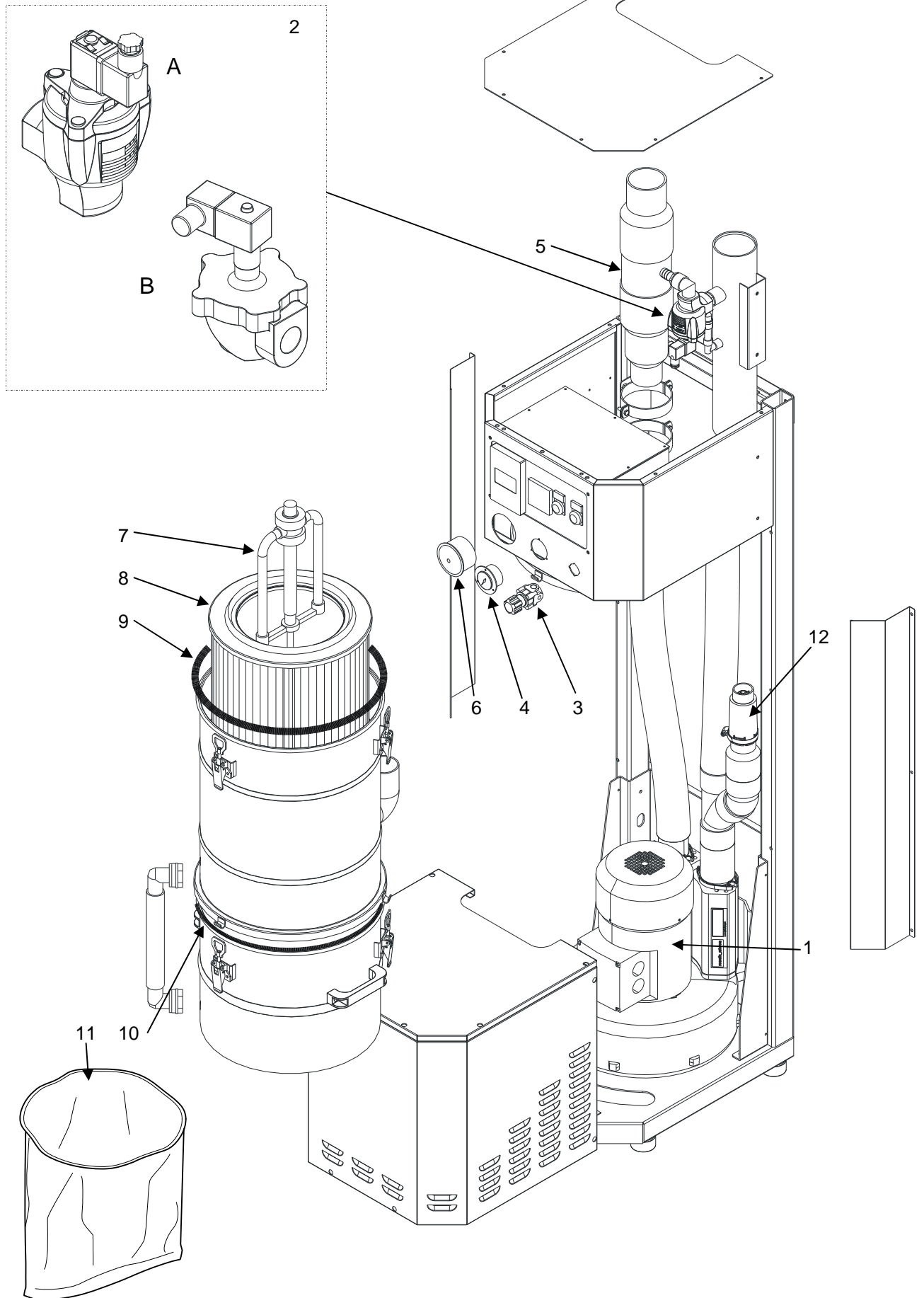

Please, see descriptions in Table 8.1 A - page 20



THE UNDERSIGNED COMPANY **C.A.V SR.L.**

VIA R. MORANDI, 93 - 40060 TOSCANELLA DI DOZZA (BO)  
TEL.: +39 0542 673488 - TELEFAX: +39 0542 672065  
E-MAIL: SALES@CAVITALY.COM - HTTP://WWW.CAVITALY.COM  
M/BO 015576  
ITALY

DECLARES, UNDER ITS OWN EXCLUSIVE RESPONSIBILITY, THAT THE MACHINE

**MODEL** Fox

**REGISTRATION NO.**

**CONSTRUCTION DATE**

TO WHICH THIS DECLARATION IS REFERRED, IS IN ACCORDANCE WITH THE FOLLOWING DIRECTIVES:

DIRECTIVE 2006/42/EC (MACHINERY DIRECTIVE)  
DIRECTIVE 2006/95/EC (LOW VOLTAGE DIRECTIVE)  
DIRECTIVE 2004/108/EC (ELECTROMAGNETIC COMPATIBILITY DIRECTIVE)

FURTHERMORE, WE DECLARE THAT THE TECHNICAL DOSSIER HAS BEEN COMPILED BY:

LUCA LUCIA  
C/O C.A.V. SRL  
VIA R. MORANDI, 93 - 40060 TOSCANELLA DI DOZZA (BO)  
TEL.: +39 0542 673488 - TELEFAX: +39 0542 672065  
E-MAIL: UT@CAVITALY.COM

TOSCANELLA,

**TECHNICAL DOSSIER COMPILER**

LUCA LUCIA

**LEGAL REPRESENTATIVE**

DOMENICO LUCIA



**Please fill in and return this form by fax  
for Warranty registration**

Date: .....

Machine model:

Serial no.:

Year of manufacture:

**To be filled in by the Customer**

Company name .....

Address .....

Phone no.: ..... Fax no.: .....

E-mail: .....

**Company name of installing firm**

.....  
.....







**C.A.V. srl**

Via R. Morandi, 93 - 40060 Toscanella di Dozza (BO)

Tel.: +39 0542 673488 / Fax: +39 0542 672065

[www.cavitaly.com](http://www.cavitaly.com) - [sales@cavitaly.com](mailto:sales@cavitaly.com)

[www.smaisystem.com](http://www.smaisystem.com) - [info@smaisystem.com](mailto:info@smaisystem.com)